

# ATOMSTACK Air Assist Kit User Manual



- English
- Deutsch
- Français
- Italiano
- Español

Note: The picture is for reference only, the actual product shall prevail.

F03-0046-0AA1 Version:C

For more information, please scan the QR code















Laser Engraver

# Parts List

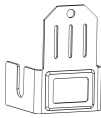
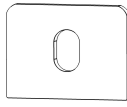

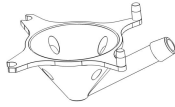
This is parts collection for various models, not each model will use all parts in the sheet.

 <p>Pump</p>	 <p>Power Adapter</p>	 <p>trachea</p>	 <p>M3 self-tapping screws</p>	 <p>Set screw</p>	 <p>Inner hexagon screwdriver</p>	 <p>PH1 Phillips screwdriver</p>
 <p>Foot pad 2pcs</p>	 <p>NO. 1 2pcs</p>	 <p>NO. 1-1</p>	 <p>NO. 1-2</p>	 <p>NO. 1-3</p>	 <p>NO. 2</p>	 <p>NO. 2-1</p>

Atomstack A5 10W	Atomstack A5 30W
Atomstack A5 20W	Atomstack A5 Pro

# Installation of Air Guide Hood for Four Models

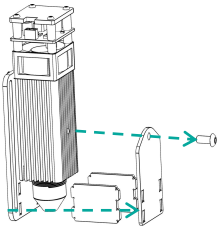

1. Remove the current acrylic shields

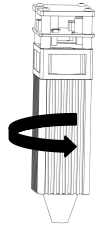

2. Rotate the laser backward 180°

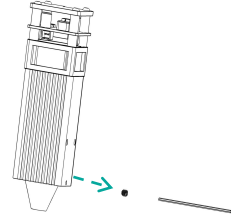

3. Remove the set screw

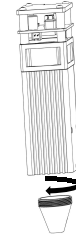

4. Rotate the current air guide hood counterclockwise to remove it.

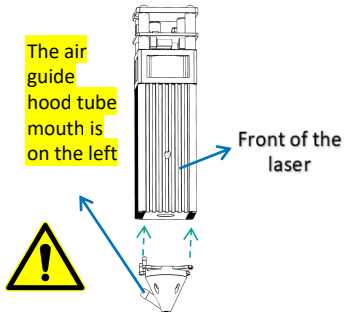

5. Find **NO.1** from the accessories. Install it as shown

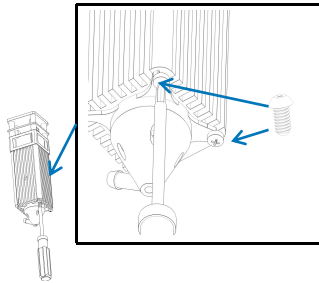

6. Tighten the self-tapping screws with a PH1 Phillips screwdriver

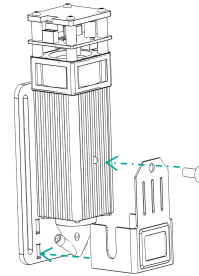

7. Find **NO.1-1** from the accessories and install it as shown.

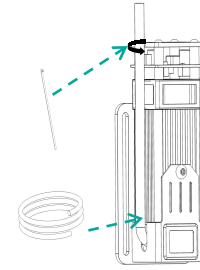

8. Insert the tube and fixed it with a tie

Atomstack A5 M50 Pro	AtomStack P9 M40	Atomstack X7 Pro	AtomStack P9 M50
AtomStack A10 PRO	Atomstack A5 M50	Atomstack S10 Pro	Atomstack X7

## Installation of Air Guide Hood for Eight Models

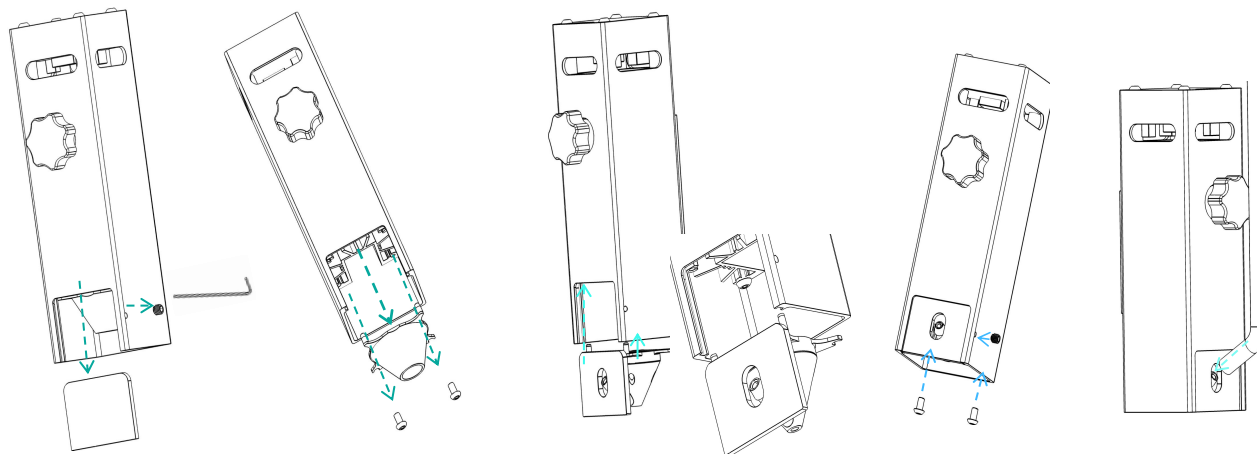

1. Remove the set screw from the right side of the laser and remove the current filter glass or acrylic shield.

2. Remove the current air guide hood.

3. Find **NO.1** and **NO.1-2** from the accessories and install them at the same time as shown.

4. Fix the air guide hood as well as the filter glass.

5. Insert the tube.



If your model is **AtomStack A5 Pro+** or **AtomStack P7 M40**, you need to choose one of the following 2 combinations to support your model.

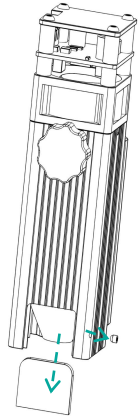

1. Remove the set screw from the right side of the laser and remove the current filter glass or acrylic shield.



2. Remove the current air guide hood.

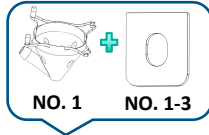

Combination one

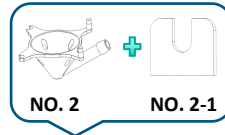

Combination two

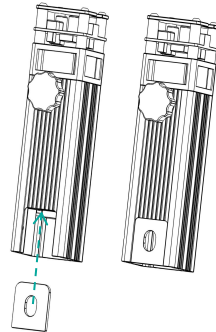

3-1

3-2

locate the combination which contains the wind deflector matches your model( If the bottom surface of the glass and the laser is flush after assembly, proves this wind deflect matches your model), choose this combination.

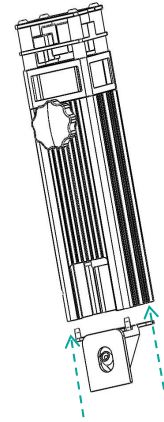

4. Install the combination matches your model, mount the air guide hood and the glass at the same time.

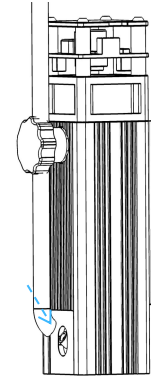

5. Insert the tube.

# Equipment installation and use

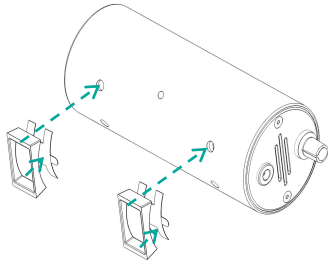

1. Tear off the adhesive protect paper from the silicone pad, align the positioning posts on the silicone pad with the mounting holes on the pump, and paste the silicone pad to pump body.

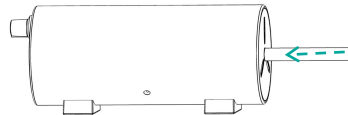

2. Insert the air tube into the air pump port

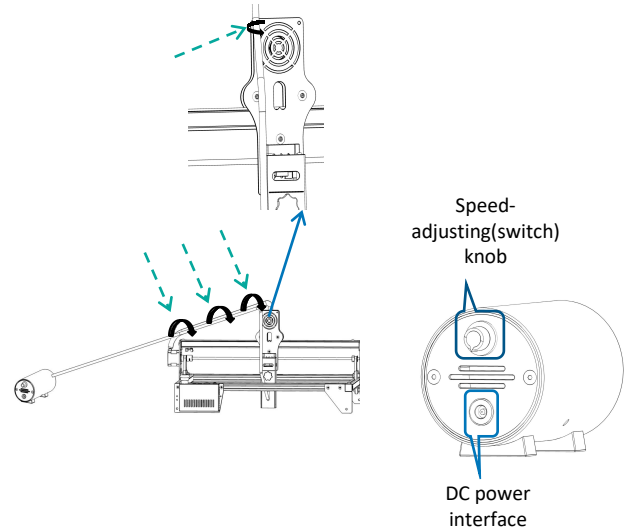

3. The tube on the machine needs to be fixed with the connecting line by the nylon tie. Be careful not to fix it too tight to block the tube.

## Precautions for Use

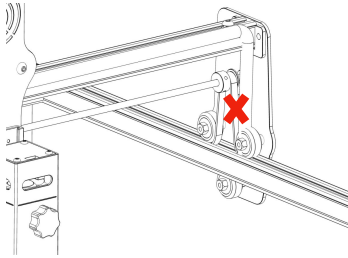

Be careful not to get the tube stuck by the wheels.

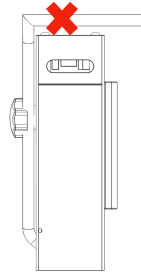

Please do not bend the tube too much to make the tube blocked.

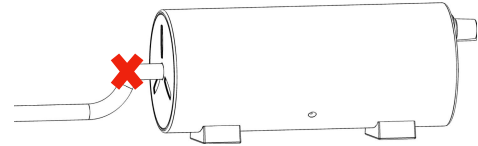

Please note the tube cannot be bent too much to make the tube blocked.



After using the air guide hood of air assist ,please clean the adhesions on the air outlet to prevent from accumulating for a long time to affect the further use.



**Customer Service:**

- For detailed warranty policy, please visit our official website at: [www.atomstack.net](http://www.atomstack.net)
- For technical support and service, please email: [support@atomstack.net](mailto:support@atomstack.net)

**Manufacturer:** Shenzhen AtomStack Technologies Co., Ltd.  
Address: 202, Building 1, Mingliang Technology Park, No. 88 Zhuguang North Road, Taoyuan Street, Nanshan District, Shenzhen, Guangdong, China

Scan the code to enter the discussion group.



Scanner APPLICATION:  
QR code reader/ Barcode scanner or any APP with scanner.



# ATOMSTACK Air Assist Kit Benutzerhandbuch

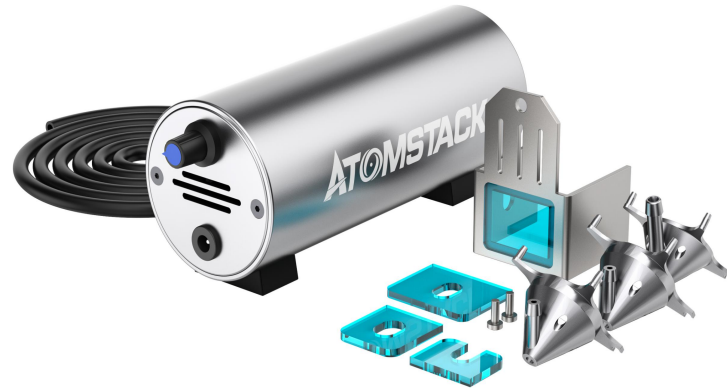

- English
- Deutsch**
- Français
- Italiano
- Español

Hinweis: Das Bild dient nur als Referenz, das tatsächliche Produkt hat Vorrang

Für weitere Informationen scannen Sie bitte den QR-Code











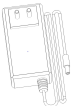

Laser Engraver

# Liste der Einzelteile

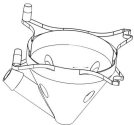
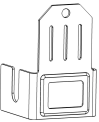
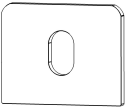

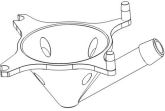
Dies ist eine Teilesammlung für verschiedene Modelle, nicht jedes Modell verwendet alle Teile im Blatt.

 <p>Pumpe</p>	 <p>Netzteil</p>	 <p>Luftröhre</p>	 <p>M3 selbstschneiden de Schrauben</p>	 <p>Feststells chraube</p>	 <p>Innensechskant- Schraubendreher</p>	 <p>PH1Kreuzschlitz chraubendreher</p>
 <p>Fußpolster 2St</p>	 <p>NEIN. 1 2St</p>	 <p>NEIN. 1-1</p>	 <p>NEIN. 1-2</p>	 <p>NEIN. 1-3</p>	 <p>NEIN. 2</p>	 <p>NEIN. 2-1</p>

Atomstack A5 10W	Atomstack A5 30W
Atomstack A5 20W	Atomstack A5 Pro

# Installation der Luftführungshaube für vier Modelle

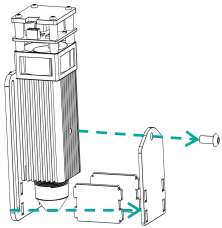

1. Entfernen Sie die aktuellen Acrylabschirmungen



Die Rohrmündung der Luftführungshaube befindet sich auf der linken Seite

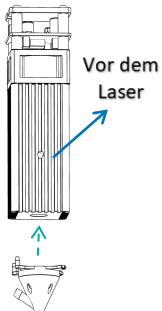

5. Finden Sie **NEIN. 1** aus dem Zubehör. Wie abgebildet installieren

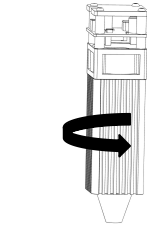

2. Drehen Sie den Laser um 180° nach hinten

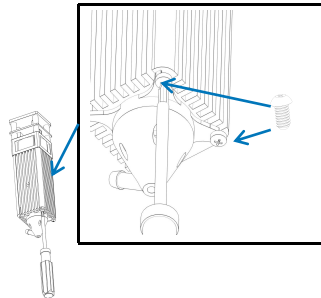

6. Ziehen Sie die Parkerschrauben mit einem Kreuzschlitzschraubendreher PH1 fest

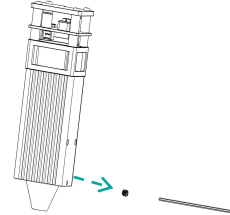

3. Entfernen Sie die Stellschraube

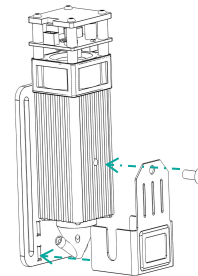

7. Finden Sie **NEIN.1-1** aus dem Zubehör und installieren Sie es wie in der Abbildung gezeigt

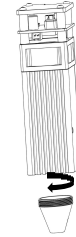

4. Drehen Sie die aktuelle Luftführung gegen den Uhrzeigersinn, um es zu entfernen

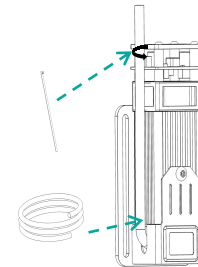

8. Führen Sie das Rohr ein und befestigen Sie es mit einem Kabelbinder

Atomstack A5 M50 Pro	AtomStack P9 M40	Atomstack X7 Pro	AtomStack P9 M50
AtomStack A10 PRO	Atomstack A5 M50	Atomstack S10 Pro	Atomstack X7

## Installation der Luftführungshaube für acht Modelle

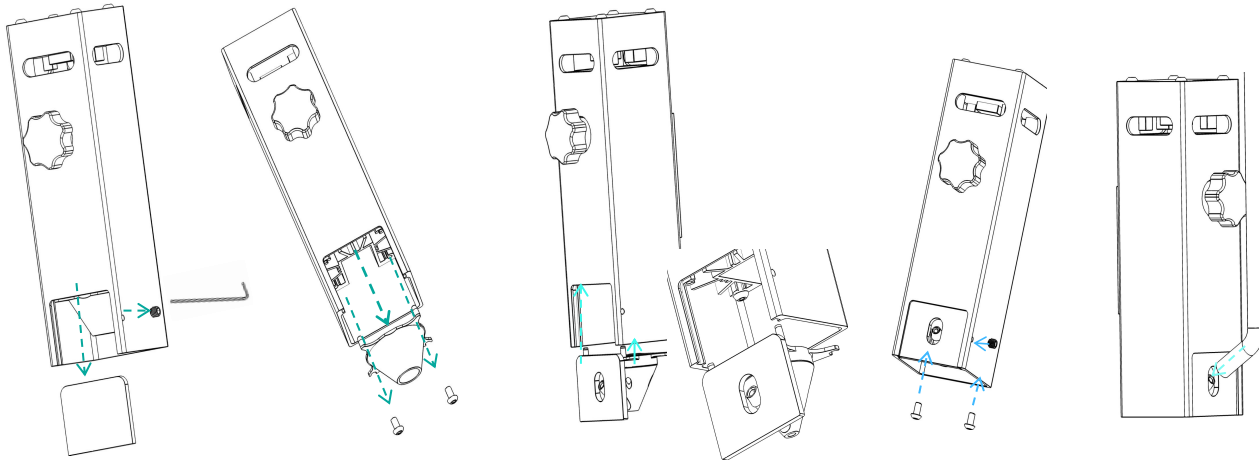

1. Entfernen Sie die Feststellschraube von der rechten Seite des Lasers und entfernen Sie das aktuelle Filterglas oder die Acrylabschirmung.

2. Entfernen Sie die aktuelle Luftführung.

3. Suchen Sie NO.1 und NO.1-2 aus dem Zubehör und installieren Sie sie gleichzeitig wie gezeigt.

4. Befestigen Sie die Luftführung sowie das Filterglas.

5. Setzen Sie das Rohr ein.



Wenn Ihr Modell AtomStack A5 Pro+ oder AtomStack P7 M40 ist, müssen Sie eine der folgenden 2 Kombinationen auswählen, um Ihr Modell zu unterstützen.

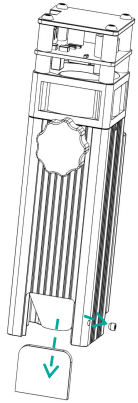

1. Entfernen Sie die Feststellschraube von der rechten Seite des Lasers und entfernen Sie das aktuelle Filterglas oder die Acrylabschirmung.



2. Entfernen Sie die aktuelle Luftführung.

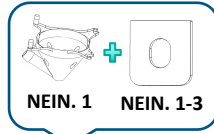

NEIN. 1    NEIN. 1-3

Kombination eins

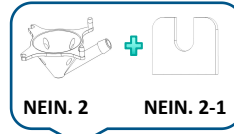

NEIN. 2    NEIN. 2-1

Kombination zwei

Suchen Sie die Kombination, die den Windabweiser enthält, der zu Ihrem Modell passt (Wenn die Unterseite des Glases und der Laser nach der Montage bündig sind, beweist, dass dieser Windabweiser zu Ihrem Modell passt), wählen Sie diese Kombination.

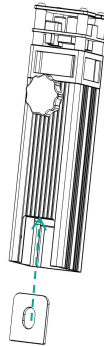

3-1

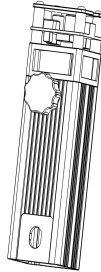

3-2

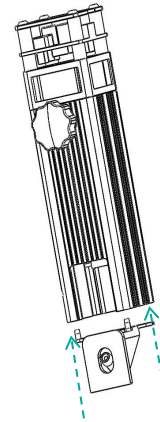

4. Bauen Sie die Kombination passend zu Ihrem Modell ein, montieren Sie gleichzeitig die Luftführung und das Glas.

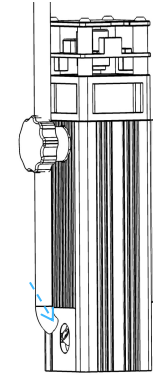

5. Setzen Sie das Rohr ein

# Geräteinstallation und -nutzung

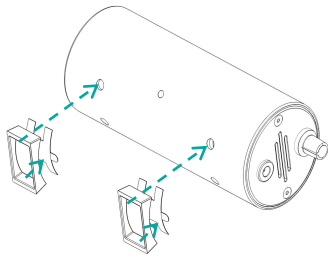

1. Reißen Sie das Klebeschutzpapier von der Silikonunterlage ab, richten Sie die Positionierungsposten auf der Silikonunterlage mit den Befestigungslöchern an der Pumpe aus und kleben Sie die Silikonunterlage auf den Pumpenkörper.

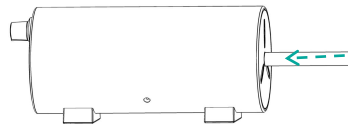

2. Stecken Sie den Luftschlauch in den Luftpumpenanschluss

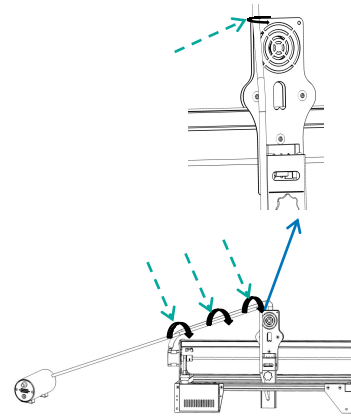

3. Der Schlauch an der Maschine muss mit der Verbindungsleitung durch den Nylonbinder befestigt werden. Achten Sie darauf, es nicht zu fest anzuziehen, um das Rohr zu blockieren.

Drehzahlstellknopf (Schalter).

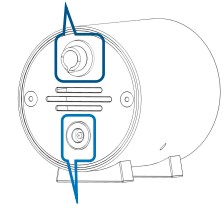

DC-Leistungsschnittstelle

# Vorsichtsmaßnahmen für die Verwendung

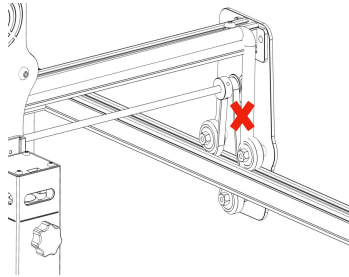

Achten Sie darauf, dass der Schlauch nicht von den Rädern erfasst wird.

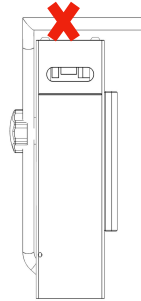

Bitte biegen Sie den Schlauch nicht zu stark, um den Schlauch zu blockieren.

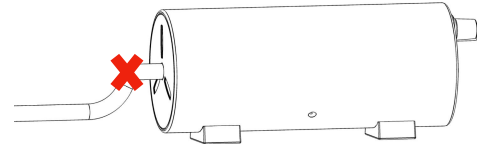

Bitte beachten Sie, dass das Rohr nicht zu stark gebogen werden darf, um das Rohr zu blockieren.



Reinigen Sie nach der Verwendung der Luftführungshaube von Air Assist die Anhaftungen am Luftauslass, um zu verhindern, dass sie sich für längere Zeit ansammeln und die weitere Verwendung beeinträchtigen.



**Kundendienst:**

➤ Für detaillierte Garantiebestimmungen besuchen Sie bitte unsere offizielle Website unter:

[www.atomstack.net](http://www.atomstack.net)

➤ Für technischen Support und Service senden Sie bitte eine E-Mail: [support@atomstack.net](mailto:support@atomstack.net)

**Hersteller:** Shenzhen AtomStack Technologies Co., Ltd.  
Die Anschrift: 202, Gebäude 1, Mingliang Technology Park, Nr. 88  
Z Huguang North Road, Tao Yuan Street, n Anshan District, S very  
real, Gebäude G von GU Plan, China

Scannen Sie den Code, um die Diskussionsgruppe zu betreten.



Scanner ANWENDUNG:  
QR-Code-Leser / Barcode-Scanner oder jede APP mit Scanner.



# ATOMSTACK Air Assist Kit Manuel d'utilisation

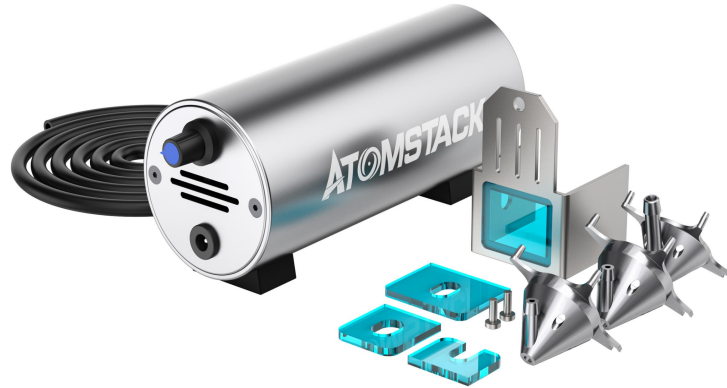

- English
- Deutsch
- Français
- Italiano
- Español

Remarque : l'image est fournie à titre indicatif uniquement, le produit réel prévaudra

Pour plus d'informations, veuillez scanner le code QR















Laser Engraver

# Liste des pièces

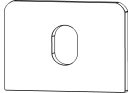
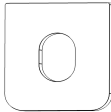
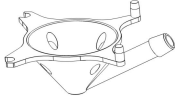

Il s'agit d'une collection de pièces pour différents modèles, chaque modèle n'utilisera pas toutes les pièces de la feuille.

 Pompe	 Adaptateur secteur	 trachée	 Visautotaraudeu ses M3	 Vis de réglage	 Tournevis hexagonal intérieur	 Tournevis cruciforme PH1
 Repose-pied 2 pièces	 NON. 1 2 pièces	 NON. 1-1	 NON. 1-2	 NON. 1-3	 NON. 2	 NON. 2-1

Atomstack A5 10W	Atomstack A5 30W
Atomstack A5 20W	Atomstack A5 Pro

## Installation du capot de guidage d'air pour quatre modèles

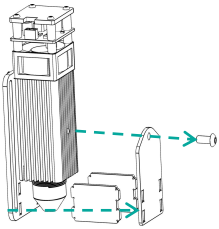

1. Retirez les boucliers acryliques actuels

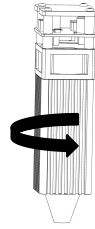

2. Faire pivoter le laser de 180° vers l'arrière

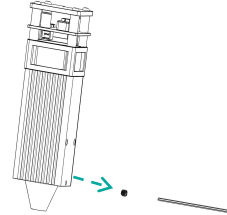

3. Retirez la vis de réglage



4. Faire pivoter le guide d'air actuel dans le sens inverse des aiguilles d'une montre pour le retirer.



L'embouchure du tube du capot de guidage d'air est à gauche

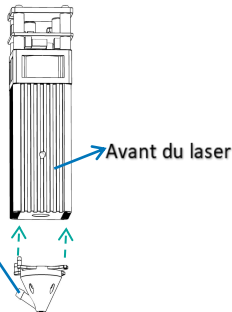

5. Trouvez **NON.1** parmi les accessoires. Installez comme indiqué

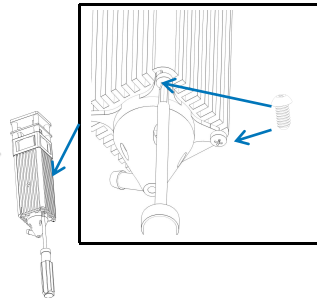

6. Serrez les vis autotaraudeuses avec un tournevis cruciforme PH1

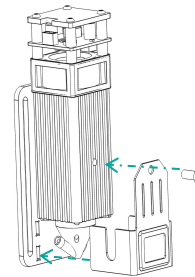

7. Trouvez **NON.1-1** parmi les accessoires et installez-le comme indiqué sur l'image

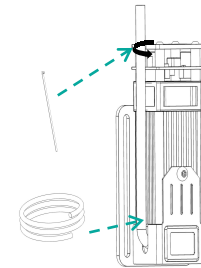

8. Insérez la trachée et fixez-la avec un lien

Atomstack A5 M50 Pro	AtomStack P9 M40	Atomstack X7 Pro	AtomStack P9 M50
AtomStack A10 PRO	Atomstack A5 M50	Atomstack S10 Pro	Atomstack X7

## Installation du capot de guidage d'air pour huit modèles

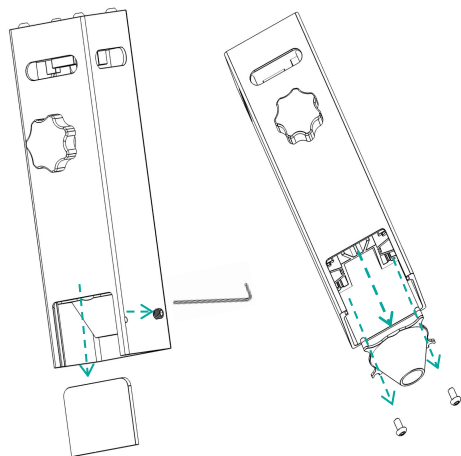

1. Retirez la vis de réglage du côté droit du laser et retirez le verre filtrant actuel ou le bouclier acrylique .

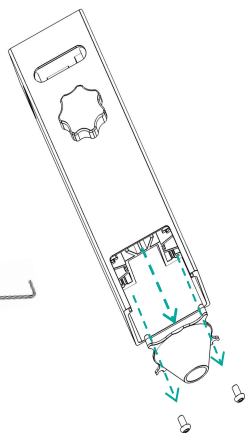

2. Retirer le guide d'air actuel.

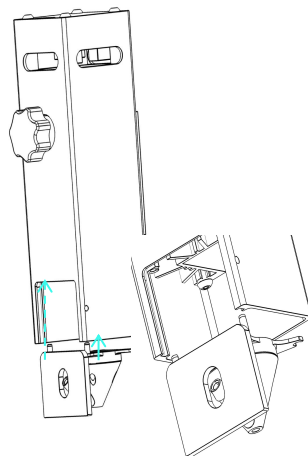

3. Trouvez NO.1 et NO.1-2 parmi les accessoires et installez-les en même temps comme indiqué.

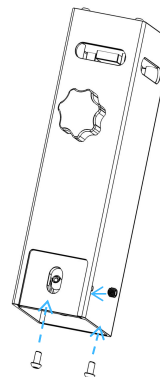

4. Fixez le guide d'air ainsi que le verre filtrant.

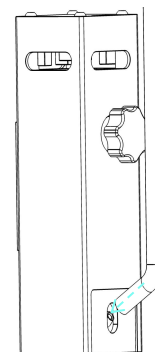

5. Insérez le tuyau.



Si votre modèle est AtomStack A5 Pro+ ou AtomStack P7 M40, vous devez choisir l'une des 2 combinaisons suivantes pour prendre en charge votre modèle.

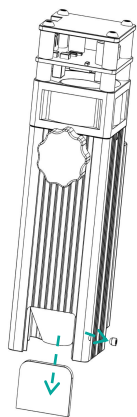

1. Retirez la vis de réglage du côté droit du laser et retirez le verre filtrant actuel ou le bouclier acrylique.



2. Retirer le guide d'air actuel.

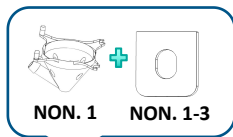

Combinaison un

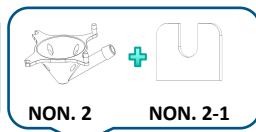

Combinaison deux

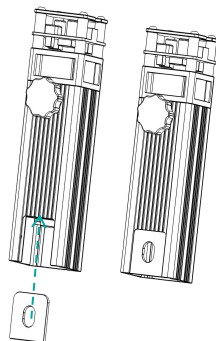

3-1

3-2

localisez la combinaison qui contient le déflecteur de vent correspond à votre modèle (si la surface inférieure du verre et le laser sont alignés après l'assemblage, cela prouve que ce déflecteur de vent correspond à votre modèle), choisissez cette combinaison.

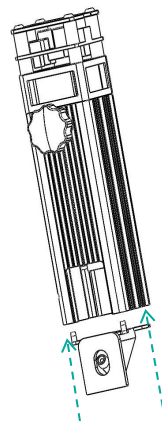

4. Installez la combinaison correspondant à votre modèle, montez le guide d'air et la vitre en même temps.

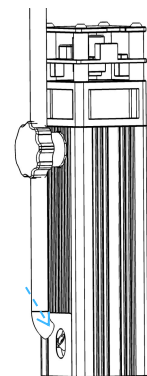

5. Insérez le tuyau.

# Installation et utilisation du matériel

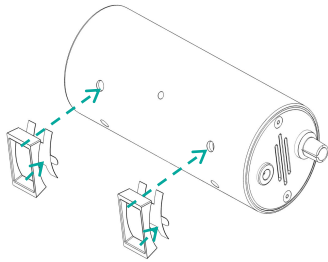

1. Détachez le papier de protection adhésif du tampon en silicone, alignez les poteaux de positionnement sur le tampon en silicone avec les trous de montage sur la pompe et collez le tampon en silicone sur le corps de la pompe.

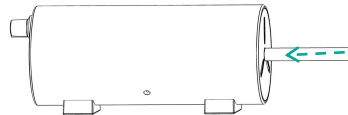

2. Insérez le tube à air dans le port de la pompe à air

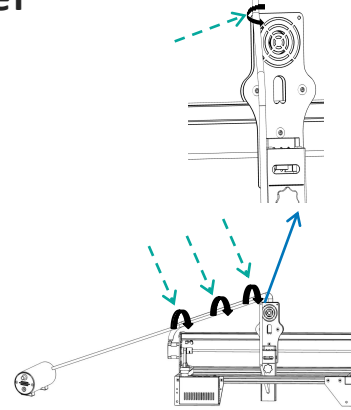

3. Le tube de la machine doit être fixé avec la ligne de connexion par l'attache en nylon. Attention à ne pas le fixer trop serré pour bloquer le tube.

Bouton de réglage de la vitesse (commutateur)

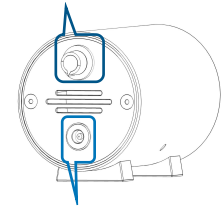

Interface d'alimentation CC

## Précautions d'emploi

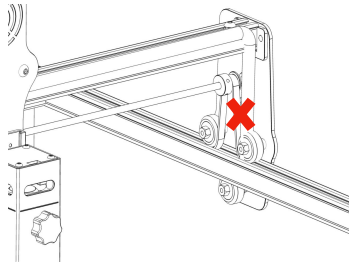

Attention à ne pas coincer le tuyau dans les roues.

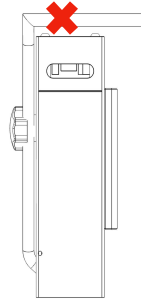

Veillez ne pas trop plier le tube pour bloquer le tube.

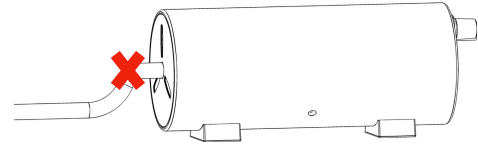

Veillez noter que le tube ne peut pas être trop plié pour bloquer le tube.



Après avoir utilisé le capot de guidage d'air de l'assistance à l'air, veuillez nettoyer les adhérences sur la sortie d'air pour éviter qu'elles ne s'accablent pendant une longue période et n'affectent l'utilisation ultérieure.



#### Service Clients:

➤ Pour une politique de garantie détaillée, veuillez visiter notre site Web officiel à: [www.atomstack.net](http://www.atomstack.net)

➤ Pour le support technique et le service, veuillez envoyer un e-mail: [support@atomstack.net](mailto:support@atomstack.net)

**Fabricant:** Shenzhen AtomStack Technologies Co., Ltd.  
Adresse: 202, bâtiment 1, parc technologique de Mingliang, n° 88  
Z route nord de Huguang, rue tao yuan, district de n Anshan, S  
très réel, bâtiment G du plan GU, Chine

Scannez le code pour entrer dans le groupe de discussion.



APPLICATIONS du scanner :  
Lecteur de code QR/scanner de code-barres ou toute application avec scanner.



# Manuale utente del kit Atomstack Air Assist

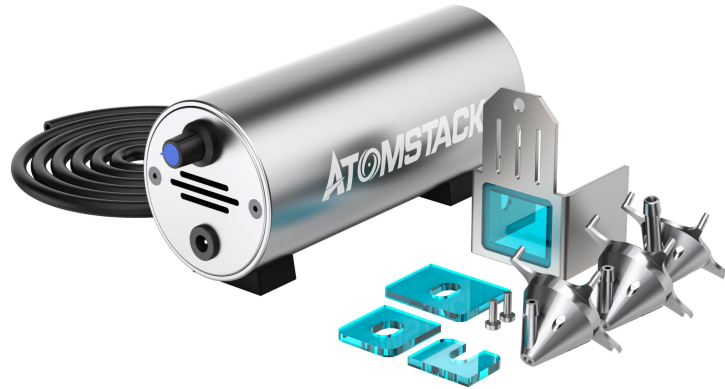

- English
- Deutsch
- Français
- Italiano
- Español

Nota: l'immagine è solo di riferimento, prevarrà il prodotto reale.

F03-0046-0AA1 Version:C

Per ulteriori informazioni, scansiona il codice QR















Laser Engraver

## Elenco delle parti

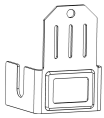
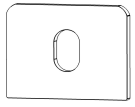

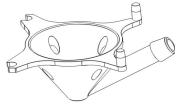
Questa è una raccolta di parti per vari modelli, non ogni modello utilizzerà tutte le parti nel foglio.

 <p>Pompa</p>	 <p>Adattatore di alimentazione</p>	 <p>trachea</p>	 <p>Viti autofilettanti M3</p>	 <p>Vite di fissaggio</p>	 <p>Cacciavite esagonale interno</p>	 <p>Cacciavite a croce PH1</p>
 <p>Cuscinetti per piedi 2 pezzi</p>	 <p>NO. 1 2pcs</p>	 <p>NO. 1-1</p>	 <p>NO. 1-2</p>	 <p>NO. 1-3</p>	 <p>NO. 2</p>	 <p>NO. 2-1</p>

Atomstack A5 10W	Atomstack A5 30W
Atomstack A5 20W	Atomstack A5 Pro

## Installazione della cappa Air Guide per quattro modelli

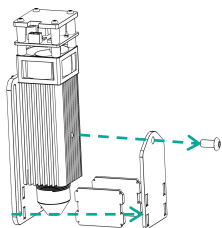

1. Rimuovere gli attuali scudi acrilici

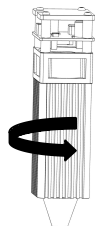

2. Ruotare il laser all'indietro di 180°

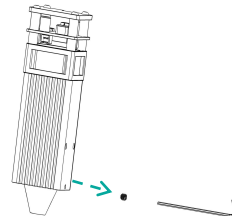

3. Rimuovere la vite di fissaggio

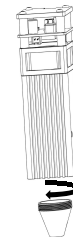

4. Ruotare l'attuale cappa di guida dell'aria in senso antiorario per rimuoverla.

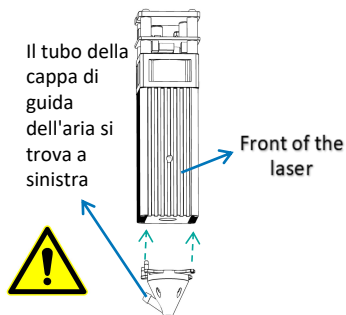

5. Trova il NO.1 tra gli accessori. Installalo come mostrato

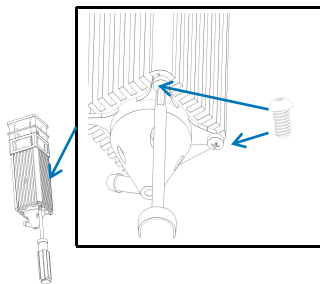

6. Stringere le viti autofilettanti con un cacciavite Phillips PH1

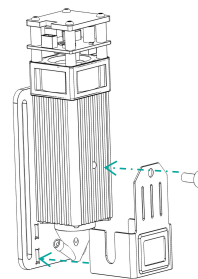

7. Trovare NO.1-1 tra gli accessori e installarlo come mostrato.

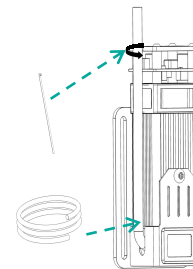

8. Inserisci il tubo e fissalo con una fascetta

Atomstack A5 M50 Pro	AtomStack P9 M40	Atomstack X7 Pro	AtomStack P9 M50
AtomStack A10 PRO	Atomstack A5 M50	Atomstack S10 Pro	Atomstack X7

## Installazione della cappa Air Guide per otto modelli

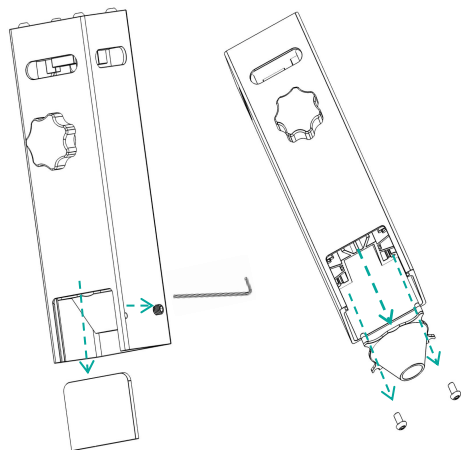

1. Rimuovere la vite di fissaggio dal lato destro del laser e rimuovere il vetro del filtro corrente o lo schermo acrilico.

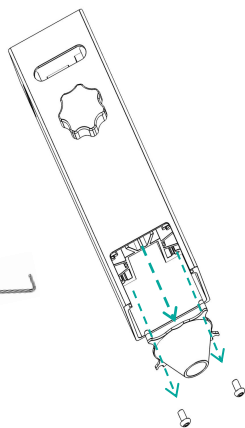

2. Rimuovere l'attuale cappa di convogliamento dell'aria.

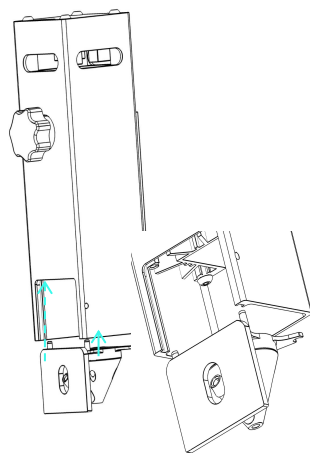

3. Trovare NO.1 e NO.1-2 dagli accessori e installarli contemporaneamente come mostrato.

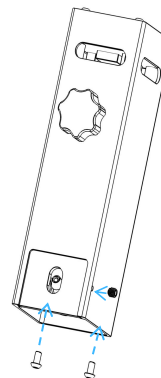

4. Fissare la cappa di convogliamento dell'aria e il vetro del filtro.

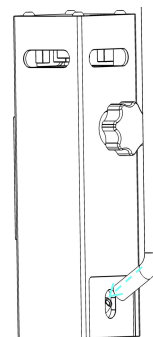

5. Inserire il tubo.



Se il tuo modello è AtomStack A5 Pro+ o AtomStack P7 M40, devi scegliere una delle 2 combinazioni seguenti per supportare il tuo modello.

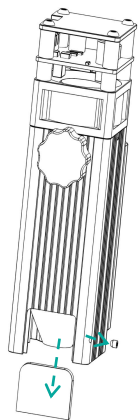

1. Rimuovere la vite di fissaggio dal lato destro del laser e rimuovere il vetro del filtro corrente o lo schermo acrilico.



2. Rimuovere l'attuale cappa di convogliamento dell'aria.

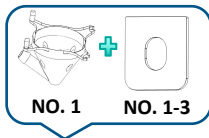

Combinazione uno

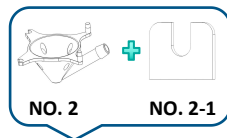

Combinazione due

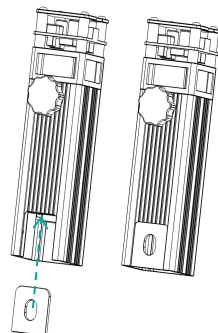

3-1

3-2

individua la combinazione che contiene il deflettore del vento che corrisponde al tuo modello (se la superficie inferiore del vetro e il laser sono a filo dopo il montaggio, dimostra che questo deflettore del vento corrisponde al tuo modello), scegli questa combinazione.

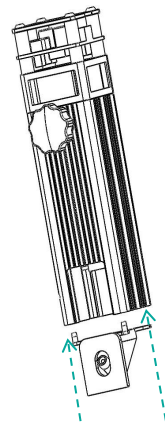

4. Installare la combinazione adatta al proprio modello, montare contemporaneamente la cappa di convogliamento dell'aria e il vetro.

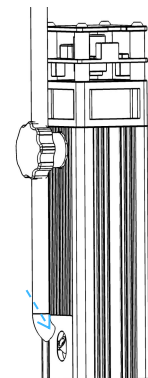

5. Inserire il tubo.

## Installazione e utilizzo dell'attrezzatura

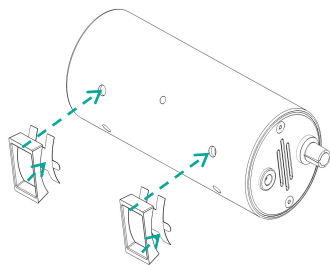

1. Strappare la carta protettiva adesiva dal cuscinetto in silicone, allineare i perni di posizionamento sul cuscinetto in silicone con i fori di montaggio sulla pompa e incollare il cuscinetto in silicone sul corpo della pompa.



2. Inserire il tubo dell'aria nella porta della pompa dell'aria

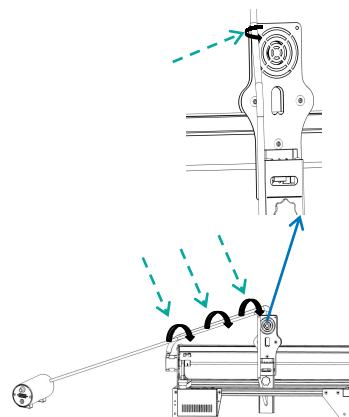

3. Il tubo sulla macchina deve essere fissato con la linea di collegamento tramite la fascetta in nylon. Fare attenzione a non fissarlo troppo stretto per bloccare il tubo.



## Precauzioni per l'uso

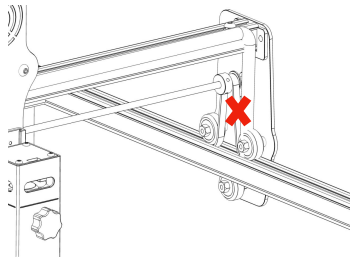

Fare attenzione a non incastrare il tubo nelle ruote.

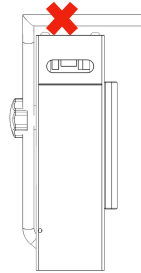

Si prega di non piegare troppo il tubo per bloccarlo.

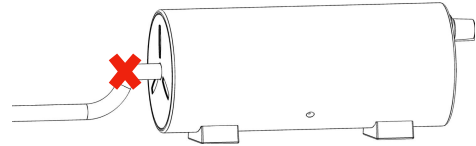

Si prega di notare che il tubo non può essere piegato troppo per bloccarlo.



Dopo aver utilizzato la cappa di guida dell'aria di Air Assist, pulire le aderenze sull'uscita dell'aria per evitare che si accumulino per lungo tempo compromettendo l'ulteriore utilizzo.



**Assistenza clienti:**

- Per una politica di garanzia dettagliata, visitare il nostro sito Web ufficiale all'indirizzo: [www.atomstack.net](http://www.atomstack.net)
  
- Per supporto tecnico e assistenza, inviare un'e-mail a: [support@atomstack.net](mailto:support@atomstack.net)

**Produttore:** Shenzhen AtomStack Technologies Co., Ltd.  
Indirizzo: 202, Building 1, Mingliang Technology Park, No. 88  
Zhuguang North Road, Taoyuan Street, Nanshan District,  
Shenzhen, Guangdong, Cina

Scansiona il codice per entrare nel gruppo di discussione.



APPLICAZIONE dello scanner:  
Lettore di codici QR/scanner di codici a barre o qualsiasi  
APP con scanner.



# Manual del usuario del kit de asistencia de aire ATOMSTACK

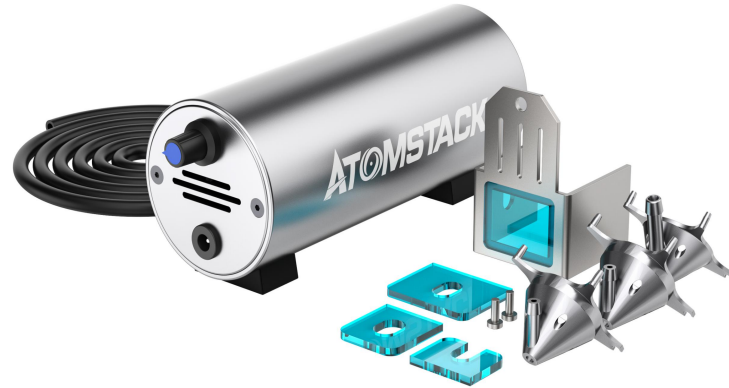

- English
- Deutsch
- Français
- Italiano
- Español

Nota: La imagen es sólo de referencia, prevalecerá el producto real.

F03-0046-0AA1 Version:C

Para más información, por favor escanea el código QR















Laser Engraver

# Lista de partes

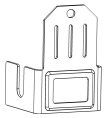
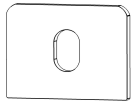

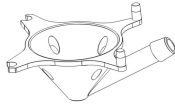
Esta es una colección de piezas para varios modelos, no cada modelo utilizará todas las piezas de la hoja.

 <p>Bomba</p>	 <p>Adaptador de corriente</p>	 <p>tráquea</p>	 <p>Tornillos autorroscantes M3</p>	 <p>Tornillo de ajuste</p>	 <p>Destornillador hexagonal interior</p>	 <p>Destornillador Phillips PH1</p>
 <p>Almohadilla para los pies 2 piezas</p>	 <p>NO. 1 2piezas</p>	 <p>NO. 1-1</p>	 <p>NO. 1-2</p>	 <p>NO. 1-3</p>	 <p>NO. 2</p>	 <p>NO. 2-1</p>

Atomstack A5 10W	Atomstack A5 30W
Atomstack A5 20W	Atomstack A5 Pro

## Instalación de capó de guía de aire para cuatro modelos

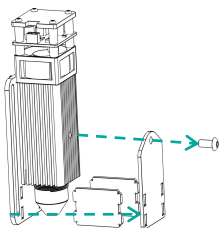

1. Retire los escudos acrílicos actuales

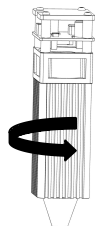

2. Gire el láser hacia atrás 180°

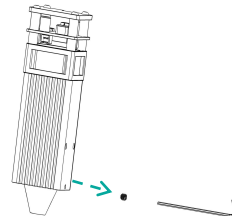

3. Retire el tornillo de fijación

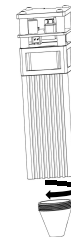

4. Gire la cubierta de guía de aire actual en sentido antihorario para retirarla.

La boca del tubo de la campana guía de aire está a la izquierda.

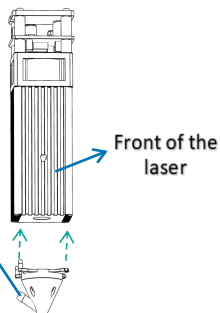

5. Encuentre el número NO.1- en los accesorios. Instálelo como se muestra

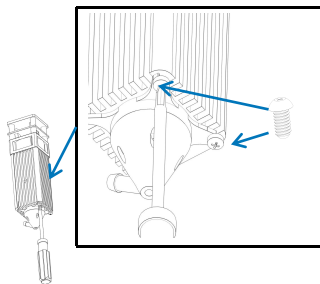

6. Apriete los tornillos autorroscantes con un destornillador Phillips PH1

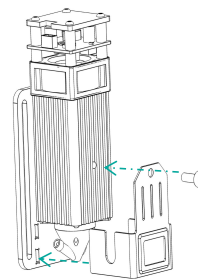

7. Busque el NO.1-1 en los accesorios e instálelo como se muestra.

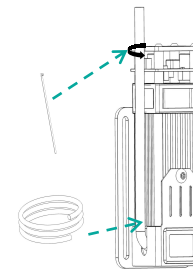

8. Introducir el tubo y fijarlo con una brida.

Atomstack A5 M50 Pro	AtomStack P9 M40	Atomstack X7 Pro	AtomStack P9 M50
AtomStack A10 PRO	Atomstack A5 M50	Atomstack S10 Pro	Atomstack X7

## Instalación de capó de guía de aire para ocho modelos

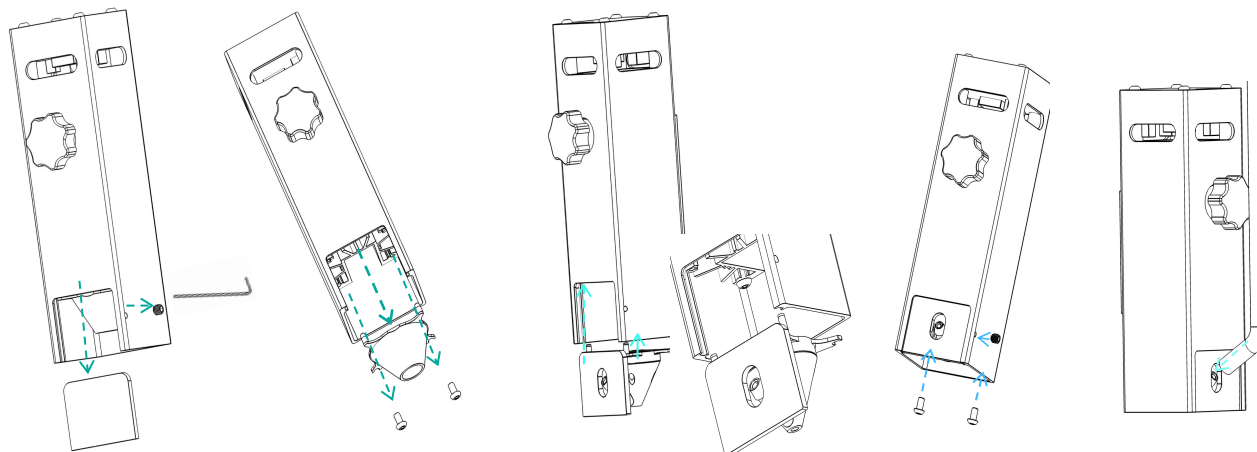

1. Retire el tornillo de fijación del lado derecho del láser y retire el filtro de vidrio o protector acrílico actual.

2. Retire la cubierta de guía de aire actual.

3. Busque los números NO.1 y NO.1-2 en los accesorios e instálelos al mismo tiempo como se muestra.

4. Fije la cubierta de conducción de aire y el cristal del filtro.

5. Inserte el tubo.



Si su modelo es AtomStack A5 Pro+ o AtomStack P7 M40, debe elegir una de las siguientes 2 combinaciones para admitir su modelo.

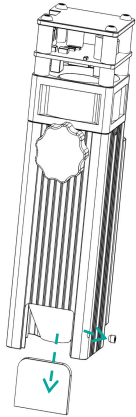

1. Retire el tornillo de fijación del lado derecho del láser y retire el filtro de vidrio o protector acrílico actual.



2. Retire la cubierta de guía de aire actual.

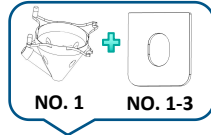

Combination one

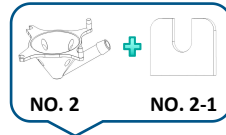

Combination two

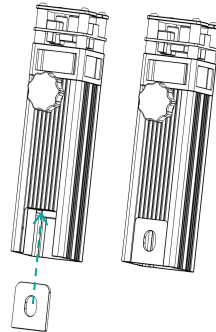

3-1

3-2

Localice la combinación que contiene el deflector de viento que coincide con su modelo (si la superficie inferior del vidrio y el láser están al mismo nivel después del montaje, esto demuestra que este deflector de viento coincide con su modelo), elija esta combinación.

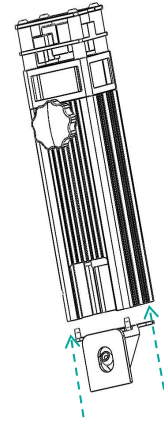

4. Instale la combinación que coincida con su modelo, monte la campana de guía de aire y el vidrio al mismo tiempo.

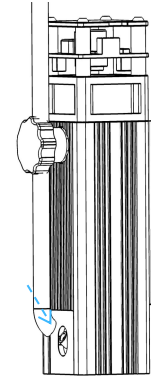

5. Inserte el tubo.

# Instalación y uso de equipos

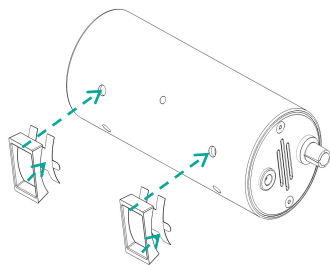

1. Retire el papel protector adhesivo de la almohadilla de silicona, alinee los postes de posicionamiento de la almohadilla de silicona con los orificios de montaje de la bomba y pegue la almohadilla de silicona al cuerpo de la bomba.



2. Inserte el tubo de aire en el puerto de la bomba de aire.

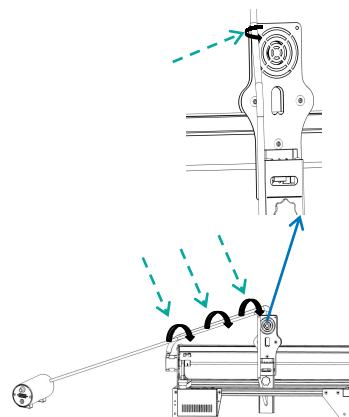

3. El tubo de la máquina debe fijarse con la línea de conexión mediante la brida de nailon. Tenga cuidado de no apretarlo demasiado para bloquear el tubo.

Perilla de ajuste de velocidad (interruptor)

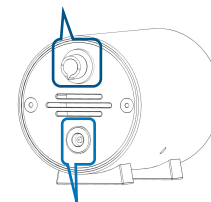

Interfaz de alimentación CC

## Precauciones de uso

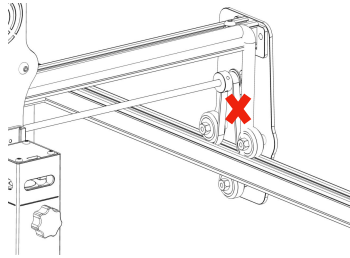

Tenga cuidado de no enganchar la cámara con las ruedas.  
con las ruedas.

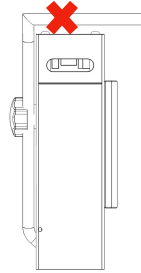

No doble demasiado el tubo para bloquearlo.

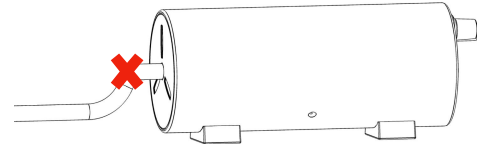

Tenga en cuenta que el tubo no se puede doblar demasiado para bloquearlo.



Después de usar la campana guía de aire de asistencia de aire, limpie las adherencias en la salida de aire para evitar que se acumulen durante mucho tiempo y afecten el uso posterior.



**Servicio al Cliente:**

- Para conocer la política de garantía detallada, visite nuestro sitio web oficial en: [www.atomstack.net](http://www.atomstack.net)
- *Para soporte técnico y servicio, envíe un correo electrónico a:* [support@atomstack.net](mailto:support@atomstack.net)

**Fabricante:** Shenzhen AtomStack Technologies Co., Ltd.  
Dirección: 202, Edificio 1, Parque Tecnológico Mingliang, No. 88 Zhuguang North Road, Calle Taoyuan, Distrito Nanshan, Shenzhen, Guangdong, China

Escanee el código para ingresar al grupo de discusión.



APLICACIÓN del escáner:  
Lector de códigos QR/Escáner de códigos de barras o cualquier APP con escáner.